



Installation manual

Mobeye MS100BK

GSM

Measure, Control and Alarm module

Table of Content

1.	Introduction	3
2.	To get ready in seven steps	4
2.1	Place the SIM Card	4
2.2	Connect a sensor	4
2.3	Insert the batteries	4
2.4	Connect the power supply	5
2.5	Program the phone numbers	5
2.6	Check the settings	5
2.7	Switching on	5
3.	Operation	6
3.1	Switching on and off	6
3.2	Alarm message confirmation	6
3.3	Controlling the outputs	6
4.	Sensors and devices	7
5.	Configuration method	8
5.1	Configuration via keypad	8
5.2	Configuration via SMS text messages	8
5.2.1	Program mode	8
5.2.2	How to Program by SMS	9
6.	Configuration possibilities	10
6.1	Installation code	10
6.2	User code	10
6.3	Telephone numbers	10
6.4	SMS ON/OFF	10
6.5	CALL ON/OFF	10
6.6	Interval test message	10
6.7	Set actual time and date	10
6.8	Automatic time-based arm/disarm	11
6.9	identification text	11
6.10	Alarm text	11
6.11	Input type	11
6.12	Input delay time	11
6.13	Inactive time	11
6.14	Power failure delay time	11
6.15	Authorisations and remote control	12
6.16	Unauthorised switching of outputs	12
6.17	Duration of outputs: Switch or pulse times	12
6.18	Initial state output	12
6.19	Reset to factory settings	12
7.	Action rules	13
7.1	Pre-programmed action rules	13
7.2	Triggers and reactions	13
7.3	Programming action rules	14
7.4	Time-based action rules	14
7.5	List of programmed action rules	14
7.6	Delete action rules	15
8.	Complete list of settings	16
9.	Reports and lists	18
9.1	Status request	18
9.2	List of settings	18
9.3	Authorisation list	18
9.4	Test GSM network strength	18
10.	Issue solving and technical data	19

Attention! Very important

This user manual contains important guidelines for the installation and usage of the Mobeye MS100BK. Please read these thoroughly before you start using the Mobeye MS100BK! In case of damage caused by disregarding the guidelines, the warranty becomes void. The user must regularly check the proper functioning of the Mobeye MS100BK. The manufacturer cannot be held liable for any damage or loss caused by any incorrect use or incorrect functioning of the Mobeye MS100BK.

Safety guidelines

- The permitted ambient temperature during operation may not be exceeded (not lower than -10°C and not higher than 55°C).
- The device is intended for use in dry and clean places.
- Protect the device from moisture, heat and water splashing. Not intended for external use.
- The guidelines for the battery usage must be regarded.
- Do not expose the device to strong vibrations.
- Do not let it fall from height.
- Do not use in an environment where any inflammable gases, vapours or dust are present or could be present.
- Repair of the device may only be carried out by people, trained for Mobeye® repair.
- If the device must be repaired, only original replacement components may be used. The use of different parts may lead to damage of the Mobeye MS100BK.

Use in accordance with the regulations

The purpose of this device in accordance with the regulations is the generation of SMS text messages and telephone calls after the activation of one of the inputs, or after an internal trigger; switching the outputs after an alarm or via incoming call/SMS. Other uses are not permitted.

Battery recycling

CR123 batteries, as used in the Mobeye MS100BK can be recycled. Please take empty batteries to a nearest collection point.

1. INTRODUCTION

The Mobeye MS100BK is an easy to install measure, control and alarm module that will send alerts using the built-in GSM communication module. It has inputs for sensors and signals. The Mobeye MS100BK can also switch external devices connected to (e.g. by SMS text message). To use the Mobeye MS100BK you will need a SIM-card. This can be a prepaid or post-paid card.

The Mobeye MS100BK has following features:

- In case one of the inputs is activated by a sensor, the Mobeye MS100BK sends an alarm SMS text message and calls the phone numbers as programmed. The SMS message contains the text 'Mobeye alarm 1' or 'Mobeye alarm 2'.
- As soon as the inputs leave the alarm status, an SMS text message is sent to the set telephone numbers containing the text such as 'Mobeye Input 1 OK' or 'Mobeye Input 2 OK'.
- If the sensor and/or the input remain in the alarm status, the Mobeye MS100BK repeats sending the SMS alarm message every four hours.
- With just batteries (no external power supply) the module remains in low-power mode, which means that the GSM network connection is disabled and only established when it needs to send an alarm, test message or "battery low" message.
- When the batteries need to be replaced, the Mobeye MS100BK sends a 'battery low' SMS text message to the administrator.
- If an external power supply is used and a power failure occurs, the Mobeye MS100BK sends a 'power failure' SMS text message and calls the phone numbers as programmed by the user. When the power is restored, the Mobeye MS100BK sends a 'power restored' SMS text message to the numbers.
- If an external power supply is used, the outputs can be switched by an incoming SMS command from an authorised telephone number.

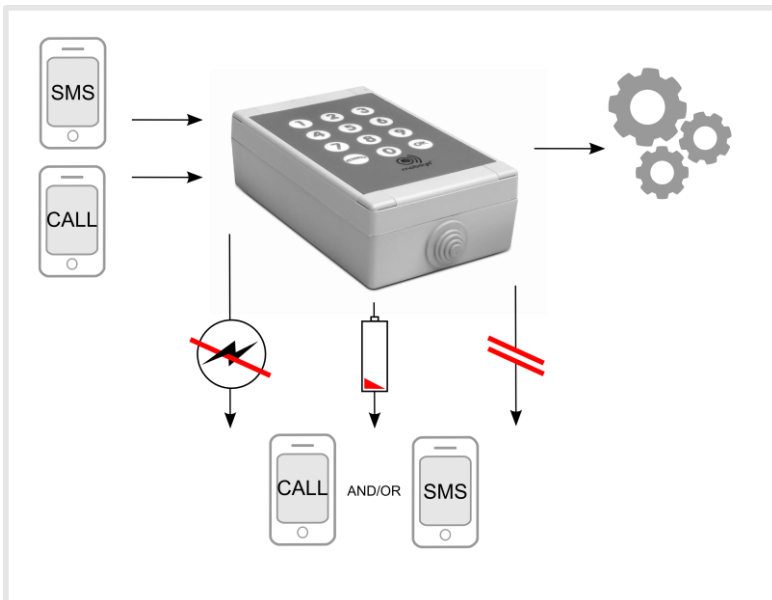

2. TO GET READY IN SEVEN STEPS

To get started with the Mobeye MS100BK seven easy steps are needed.

1. Place the SIM card
2. Connect a sensor to the input
3. Insert the four batteries
4. Connect the power supply
5. Enter at least one phone number
6. Check the settings
7. Switching on

2.1 PLACE THE SIM CARD

To use the Mobeye MS100BK a SIM card from any network is needed. On this SIM card, the PIN code security needs to be disabled or 0000. If you have a SIM card with PIN code, you can disable or change this using any mobile phone and change the PIN code security. Please consult the manual for that mobile phone for the procedure.

The SIM card needs to be inserted before the batteries. When using a prepaid SIM card, take note of the available credit. Additionally it is wise to set a recurrent test message in the menu so the card will be used at least once a month.

- Open the back cover
- Insert the SIM card in the holder. For opening/closing, move the cover slightly.

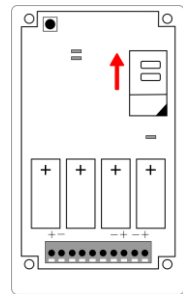

2.2 CONNECT A SENSOR

Open the hole in the enclosure and insert the 2 wires of an external sensor through the hole of the enclosure to the inside part and next in the two connectors of input 1 (press the orange pins for connecting the wires). It does not matter which wire is connected to which connector. If necessary the wires can be extended using appropriate wire material.

If the sensor should be closed in normal situation (and be opened in the event of an alarm), the input type should be changed (please refer to paragraph 6.11).

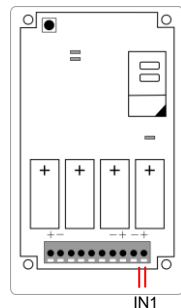

2.3 INSERT THE BATTERIES

Insert the four lithium 3,0 volt batteries (CR123). When replacing the batteries, all settings remain unchanged.

After inserting the SIM card and the batteries, the Mobeye MS100BK will perform a self test taking 1 minute. During the test, the light is red.

If the light is flashing red, a problem with the SIM card is detected. A reason could be no SIM card was placed, or the PIN code security of the SIM card was not disabled.

2.4 CONNECT THE POWER SUPPLY

The Mobeye MS100BK is designed to run on batteries, or to use an external power supply (9-32VDC). Using external power, the module is always in connection with the GSM network. This gives following advantages: a longer battery lifetime, possibility to receive power failure messages (using the batteries) and the possibility to perform remote actions, such as arm/disarm, switch the outputs, ask status reports and to program it via SMS-commands.

Connect the external power adapter (or any other regulated 9-32VDC power supply) to the power input of the connector (press on the orange pins for connecting the wires):

- V+ (black lead with white stripe) to “+”
- Ground (black lead) to “-“

If using the Mobeye mains adapter (Mobeye article 10027):
The black wire with the white line is “+”, the other black wire is “-“.

Close the Mobeye MS100BK using the 4 screws.

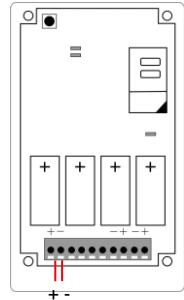

2.5 PROGRAM THE PHONE NUMBERS

You need to program at least one phone number in the unit as alarm number.

- Enter your 4 digit code (factory setting: “1111”)
- Press “menu”
- Enter “101”
- Press “OK”
- Enter the phone number (e.g. 0712345678 or 0044712345678)
- Press “OK”

The light turns green and a confirmation melody is played. The Mobeye MS100BK is ready to use.

2.6 CHECK THE SETTINGS

The settings can be sent to the programmed telephone number as SMS text message. In this way you also check the correct working of the SIM card.

- Enter your 4 digit code (factory setting: “1111”)
- Press “menu”
- Enter “10”
- Press “OK”

Within ca. 30 seconds the programmed phone number (TEL1) will receive the list with settings.

2.7 SWITCHING ON

The Mobeye MS100BK is switched on automatically after programming the first telephone number. To switch on/off manually, please refer to 3.1.

3. OPERATION

3.1 SWITCHING ON AND OFF

To activate the Mobeye MS100BK, use the installation code or user code.

- Enter your code
- Press “OK”

The light turns red shortly and an indication tone is started for a few seconds.

If the code is entered incorrectly 3 times, the indicator turns red and the Mobeye MS100BK will be blocked for 10 minutes.

The action can be interrupted at any time, by twice pressing “OK”.

To de-activate the Mobeye MS100BK with your code.

- Enter your code
- Press “OK”

The light switches to green and a confirmation melody is played.

3.2 ALARM MESSAGE CONFIRMATION

When the sensor of the (armed!) system is activated, it will send an alarm notification. If the unit is battery operated first the GSM module starts to establish a connection to the network. First an SMS text message is sent to all programmed alarm numbers; next a phone call is made to the numbers. When you answer the phone, a beep tone is heard.

Confirm using “1”

It is possible to confirm the phone call by answering the phone and pressing “1”. The other alarm numbers will not be called afterwards.

3.3 CONTROLLING THE OUTPUTS

The relay outputs can be switched in three ways:

1. Automatically after an alarm (see 7.1)
2. After an incoming call or SMS text message from an authorised telephone number (or, in case this option was set, unauthorised) (see 6.15 and 6.16).
3. Via the keypad:

Switch on Output 1	CODE	menu 311	OK
Switch off* Output 1	CODE	menu 310	OK
Switch on Output 2	CODE	menu 321	OK
Switch off* Output 2	CODE	menu 320	OK

* if an output pulse time was set, the relay outputs will switch back automatically. If the pulse time was set to “0”, they shall be switched back manually (see 6.17).

4. SENSORS AND DEVICES

Several external sensors can be connected to the two inputs. The Mobeye MS100BK can also switch external devices connected to it via the outputs after receiving an SMS command.

And although the Mobeye MS100BK is designed to run on batteries, it is possible to use an external power supply in order to report power failure and to remotely control the system.

Please find below the architecture of the main unit.

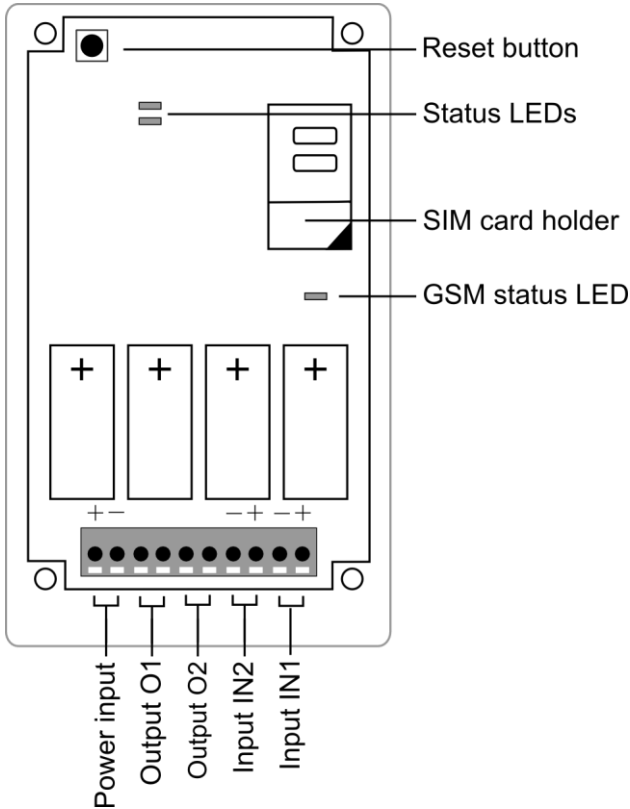

Inputs

External sensors can be connected to the inputs. Upon closing (or opening) an input, the Mobeye MS100BK will send an alarm message to the set alarm numbers (factory default: SMS and call).

Outputs

The Mobeye MS100BK has two outputs (O1 and O2). These relay outputs can switch external devices. The maximum load is 2A/30V per output.

When connected to an external power, the GSM module is active all the time, able to receive SMS commands. This enables remote control (see 6.15).

5. CONFIGURATION METHOD

The Mobeye MS100BK settings can be changed via the keypad or via SMS commands. First the method of programming is discussed, in next chapter the settings are described.

5.1 CONFIGURATION VIA KEYPAD

To configure the settings via the keypad, follow these instructions:

- Enter your 4-digit code (factory setting is "1111")
- Press "menu" - light turns green
- Enter the menu number (see list below)
- Press "OK"
- Enter the new setting
- Press "OK".

The light switches off, a confirmation melody is played



In the event of an incorrect entry, the light turns red and a short beep sounds. The menu can be left from any position, by twice pressing "OK".

Examples (code is 1111):

To program a telephone number at memory position 2
1111 MENU 102 OK 004934578692 OK

To set the SMS to OFF (just call):
1111 MENU 12 OK 0 OK

5.2 CONFIGURATION VIA SMS TEXT MESSAGES

Almost all options can be set via the keypad (except the texts). It is also possible to program by sending SMS commands to the SIM cards' telephone number in the Mobeye MS100BK.

5.2.1 Program mode

If the unit runs on external power, it is always in program mode, ready to receive SMS commands.

For programming a battery operated Mobeye MS100BK, first switch to the program mode:

- Enter your 4-digit code
- Press "menu" -> light turns green
- Enter "21"
- Press "OK"

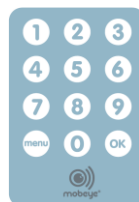

First the light flashes red (interval ca. 1 sec). As soon as the light turns green, the Mobeye MS100BK is able to receive SMS-messages. After five minutes there is a time-out and a beep is heard. Leave the program mode earlier by pressing "OK" twice.

5.2.2 How to Program by SMS

- Be sure the unit is in program mode
- Send an SMS message with following content:

CODE COMMAND:OPTION

- The CODE stands for the installation code. Factory setting is "1111".
- Do not forget the space between CODE and COMMAND.
- The complete scheme with SMS commands is listed chapter 8.
- The commands are case sensitive.
- Several commands may be combined in one SMS message (with a maximum of 160 characters) by placing a # between the commands.

CODE COMMAND:OPTION#COMMAND:OPTION#COMMAND:OPTION

A confirmation melody is played to indicate a correct command. In the event of an incorrect command, a beep is heard.



Example: To program a telephone number at memory position 2:

1111 TEL2:+4934578692



Example: To set the SMS to OFF (just call):

1111 CALLALARM:OFF

Or: both commands in one message:



Example:

1111 TEL2:+4934578692#CALLALARM:OFF

6. CONFIGURATION POSSIBILITIES

This chapter describes the possible settings in the Mobeye MS100BK.

6.1 INSTALLATION CODE

The installation code is the 4-digit code for switching on/off and programming the settings or activating the special functions. Factory default is "1111". It is possible to change the code to any 4-digit number. Please change the code to make the unit more secure.

6.2 USER CODE

The Mobeye MS100BK offers the possibility to set a personal 4-digit user code, for just arming and disarming the system. It is not possible to change the settings with the user code. The system needs to be switched on and off using the same code; the installation code and user code are not interchangeable. Factory settings for the user code is "8888". This code can be changed by the installation code or user code (menu number 50). We recommend that you change this code to make the unit more secure.

6.3 TELEPHONE NUMBERS

Up to five telephone numbers can be programmed in to the Mobeye MS100BK. In the event of an alarm the Mobeye MS100BK first sends an SMS text message to all numbers, next they are called. It is possible to confirm the call, after which the other numbers will not be called anymore.

Note: the first telephone number is required, the others are optional.

6.4 SMS ON/OFF

By default, the Mobeye MS100BK sends alarm notifications via text message and calls to the preset contact persons. By turning off the SMS, the unit will only call after the sensors send an alarm.

6.5 CALL ON/OFF

By default, the Mobeye MS100BK sends alarm notifications via text message and calls to the preset contact persons. By turning off the CALL, the unit will only send an SMS text message as alarm notification. It is not possible to switch off both the SMS and the call.

6.6 INTERVAL TEST MESSAGE

The Mobeye MS100BK can send test messages. Through these 'keep alive' reports you will be informed about the status of your Mobeye MS100BK. You can set the interval between the test reports. This is adjustable between 0 (no test reported) and 30 (every 30 days a test message). Note when MS100BK is battery-operated: the interval of 1 day will result in a daily test message; the exact time between the messages will be about 24 hours.

The smaller the interval between the test reports, the shorter is the battery life. The test message only works if the system is on.

6.7 SET ACTUAL TIME AND DATE

If the system is to be armed automatically, the internal clock time needs to be correct. Some Telecom providers offer this in the network, to be synchronised by the Mobeye MS100BK during the start-up and after sending test messages. It is possible to set the time and date manually. To view the clock time, send a list of the settings to the first programmed phone number (CODE MENU 10 OK).

6.8 AUTOMATIC TIME-BASED ARM/DISARM

The MS100BK can be armed and/or disarmed based on a daily time schedule. The first telephone number needs to be set before the arming and/or disarming time can be set.

6.9 IDENTIFICATION TEXT

It is possible to add a standard identification text (NAME) to all messages sent out by the MobeYE MS100BK. The alarm messages are a combination of the name and the alarm text. A user defined identification has a length of maximum 20 characters. The default identification text is 'MobeYE'.

The identification text cannot be changed by keypad, just by SMS command.

6.10 ALARM TEXT

Custom alarm texts can be programmed. These texts have a maximum length of 20 characters.

The following texts are programmed as factory default:

Power failure	TEXT2: power failure
Power restored	TEXT3: power restored
Triggered input 1	TEXT4: alarm 1
Triggered input 2	TEXT5: alarm 2
Restored input 1	TEXT6: Input 1 restored
Restored input 2	TEXT7: Input 2 restored

The alarm text cannot be changed by keypad, just by SMS command.

6.11 INPUT TYPE

The input type defines the character of the inputs IN1 and IN2. This can be Normally Open (NO) or Normally Closed (NC). If an input is set to NO, the alarm will be triggered as soon as the terminals of the input are closed. If the input is set to NC, the alarm is triggered if the connection between the input terminals is broken.

The default input type is set to NO.

6.12 INPUT DELAY TIME

The input delay time defines the time that the inputs are triggered before an alarm is initiated. If the input returns to the non-alarm status within the delay time, no alarm is sent. The delay time can be set between 0 and 999 seconds.

As default, the input delay time is set to 1 second.

6.13 INACTIVE TIME

The "inactive time" defines the time the movement sensor, input 1 or input 2 is not active after an activation. If the time is set to "0" (minutes), the input is active again immediately after returning to the non-alarm status. If the time is set to e.g. 30 minutes, the input remains inactive for the first 30 minutes. If the input is again (or still) activated after these 30 minutes, a new alarm message is sent. The inactive time can be set between 0 and 60 minutes.

As default, the inactive time is set to "5" for all inputs.

6.14 POWER FAILURE DELAY TIME

The power failure delay time defines the time that the power fails before an alarm is initiated. If the power is restored within the delay time, no alarm is sent. The delay time can be set between 0 and 60 minutes. As default, the delay time is set to 1.

6.15 AUTHORISATIONS AND REMOTE CONTROL

When powered externally, the GSM module is always 'on', able to receive SMS commands. This enables both programming and remote control. Remote control actions are: arming, disarming and switching the outputs. As prerequisite for remote control the 'controlling telephone number' needs to be authorised. A maximum of fifty numbers can be authorised via keypad or SMS command. If it is not clear what memory positions are available, it is possible to add a new number by the SMS command 'ADDTELA'. The new number takes the first free position.

To receive a list with the authorised numbers, please refer to 9.3.

SMS-commands for remote control (no code is necessary, numbers need to be authorised):

Arm:	ARM
Disarm:	DISARM
Switch on output 1:	O1ON
Switch off output 1:	O1OFF
Switch on output 2:	O2ON
Switch off output 2:	O2OFF

6.16 UNAUTHORISED SWITCHING OF OUTPUTS

Although the Mobeye MS100BK is designed to only switch the outputs by an incoming SMS (or call, see chapter 7) from an authorized phone, there is also an option to let them be switched by any incoming call/SMS, without being authorised. To disable the need for authorised numbers, the 'authorization' option can be set to OFF. Default is ON.

6.17 DURATION OF OUTPUTS: SWITCH OR PULSE TIMES

If an output is used, the time this output is activated can be set between 1 and 9999 seconds. If the setting is set to 0, the output does not return to its previous state automatically. An authorised number can switch it back by the SMS command O1OFF or O2OFF. In the factory settings the duration of the pulse time for the outputs is "10".

6.18 INITIAL STATE OUTPUT

In the factory settings the outputs are set to "open" (NO); they close after e.g. the SMS command "O1ON". This initial state can be set to "closed" (NC).

6.19 RESET TO FACTORY SETTINGS

It is possible to reset the Mobeye MS100BK to factory settings.

Via the keypad

- Enter your 4 digit installation code (factory setting: "1111")
- Press "menu"
- Enter "99"
- Press "OK"

Via the reset button

- Remove power adapter and /or batteries
- Restore the power source and keep the reset button pressed for about 15 seconds until a short melody sounds followed by 3 beeps.
- Release the button when the LED flashes

After several seconds a short confirmation tone is heard. The installation code is also reset to 1111.

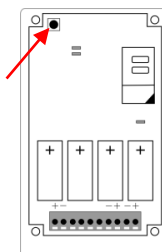

7. ACTION RULES

The alarm message and behaviour of the outputs of the Mobeye MS100BK are programmed by action-reaction patterns. These so-called Action Rules are pre-programmed, according to the needs of many applications. However, it is possible to change these action rules (for advanced users only!).

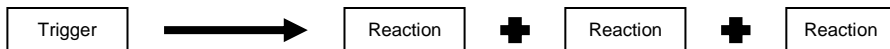

The trigger + related reactions are called an “action rule”. Each action rule may contain 3 reactions. A maximum of 15 action rules can be programmed.

7.1 PRE-PROGRAMMED ACTION RULES

In the factory defaults following action rules are pre-programmed:

Action rule number	Trigger	Reaction
1	Receive SMS	Switch outputs
2	Power failure	Send SMS + call
3	Power restored	Send SMS
4	Input 1 triggered	Send SMS + call
5	Input 2 triggered	Send SMS + call
6	Input 1 restored	Send SMS
7	Input 2 restored	Send SMS

The SMS texts are stored with a text number referring to the number of the action rules (e.g. TEXT2 and TEXT3). Texts for new action rules are stored and can be changed too (e.g. TEXT8). Please refer to 6.10.

7.2 TRIGGERS AND REACTIONS

TRIGGERS

For defining your own action rules, you can use triggers and combine them with reactions. As trigger the following events can be used:

Trigger	Command
Input 1 triggered	IN1
Input 2 triggered	IN2
Input 1 restored	IN1RESET
Input 2 restored	IN2RESET
Power failure	POWERFAIL
Power restore	POWERRESET
Incoming call	CALL
Time	TIME:hhmm (e.g. TIME:1230)

REACTION

Each trigger can initiate a maximum of 3 reactions out of the following list:

Reaction	Command	Remark
Switch Output 1	O1ON, O1OFF, O1TGL	Toggle means the output switches each time the action is executed, regardless the current status
Switch Output 2	O2ON, O2OFF, O2TGL	
Send SMS	SEND:text	Max. 20 characters. An alarm SMS contains the identification text and the text as defined here. The text is also stored as TEXTy, where y stands for the action rule number.
Call	CALL	The unit calls the set alarm numbers. The receiver will hear a 2-tone signal and can confirm by pressing '1'.

7.3 PROGRAMMING ACTION RULES

Send following SMS commands in following format:

CODE TRIGGER:REACTION1,REACTION2,REACTION3



Example: Switch output 2, call and send SMS text 'Pump failure' after a triggered input2:

1111 IN2:O2ON,CALL,SEND:Pump failure



Example: Switch output 1 after a triggered input1:

1111 IN1:O1ON

- Do not forget the space between CODE and the TRIGGER.
- The Mobeye MS100BK will play a short melody to indicate a successful configuration. In case of a wrong command, a long beep will sound.

7.4 TIME-BASED ACTION RULES

It is possible to let the action be daily performed at a certain time. The time is the trigger. To program a time-based action, include the time in the action rule, in following way.

CODE TIME:hhmm:REACTION



Example:

1111 TIME:1115:O1ON

7.5 LIST OF PROGRAMMED ACTION RULES

A list of programmed action rules, the Action Rules List (ARL), can be requested by sending following SMS to the unit.

Request programmed action rules:

CODE ARLREPORT?



Example:

1111 ARLREPORT?

7.6 DELETE ACTION RULES

An action rule can be deleted by an SMS by the command below incl. index number. The index number is the sequence number of the action rule as displayed in the ARLREPORT.

CODE DELARL:indexnumber



Example:

1111 DELARL:1

Remark: a rule will keep its index number, even if a rule with a previous number is deleted. This will result in "gap" in the index list. If a new Action Rule is added, this rule will get the index number of the first empty position.

8. COMPLETE LIST OF SETTINGS

Setting		Menu/ command	Options	Factory default
Installation code	Keypad	00	4 digits	1111
	SMS	INSTCODE:		
Interval test message	Keypad	05	0, 1, 2, 3, ... or 30 (days)	0
	SMS	TEST:		
SMS on/off	Keypad	12	0 (off), 1 (on)	1 (ON)
	SMS	SMSALARM:		
CALL on/off	Keypad	13	0 (off), 1 (on)	1 (ON)
	SMS	CALLALARM:		
User code	Keypad	50	4 digits	8888
	SMS	USERCODE:		
Actual time	Keypad	60	hhmm	
	SMS	SETTIME:		
Actual date	Keypad	61	yyyymmdd	
	SMS	SETDATE:		
Automatic arming time	Keypad	62	hhmm	
	SMS	TIMEARM:	hhmm (delete by "0")	
Automatic disarming time	Keypad	63	hhmm	
	SMS	TIMEDISARM:	hhmm (delete by "0")	
Input type input 1	Keypad	71	0 (off), 1 (NO), 2 (NC) OFF, NO, NC	1 (NO)
	SMS	TYPEIN1:		
Input type input 2	Keypad	72	0 (off), 1 (NO), 2 (NC) OFF, NO, NC	1 (NO)
	SMS	TYPEIN2:		
Inactive time Input 1	Keypad	73	0..999 (min.)	5
	SMS	INACTIVEINP1:		
Inactive time input 2	Keypad	74	0..999 (min.)	5
	SMS	INACTIVEINP2:		
Delay time input 1	Keypad	75	0..999 (sec.)	1
	SMS	DELAY1:		
Delay time input 2	Keypad	76	0..999 (sec.)	1
	SMS	DELAY2:		
Power failure delay time	Keypad	77	00..60 (min.)	1
	SMS	DELAYPOW:		
Pulse time output 1	Keypad	81	1..9999 (sec.)	10
	SMS	TO1:		
Pulse time siren/output 2	Keypad	82	1..9999 (sec.)	10
	SMS	TO2:		
Repeat	Keypad	84	0..99 (hours)	4
	SMS	REPEAT:		
Initial state output 1	Keypad		OFF, ON	OFF
	SMS	INITSTATEO1:		
Initial state output 2	Keypad		OFF, ON	OFF
	SMS	INITSTATEO2:		
TEL1	Keypad	101	Telephone number	
	SMS	TEL1:		
TEL2	Keypad	102	Telephone number	
	SMS	TEL2:		
TEL3	Keypad	103	Telephone number	
	SMS	TEL3:		

Setting		Menu/ command	Options	Factory default
TEL4	Keypad	104	Telephone number	
	SMS	TEL4:		
TEL5	Keypad	105	Telephone number	
	SMS	TEL5:		
Delete telephone number	Keypad	101...105	0	
	SMS	DEL1...DEL5		
Authorise telephone number	Keypad	201...250	Tel. number	
	SMS	TELA1: ...TELA50: of ADDTELA:		
Delete authorised number	Keypad	201...250	0	
	SMS	DELA:1..DELA:50		
Authorised remote control	Keypad	90	ON, OFF	ON
	SMS	AUTH:		
Identification text	Keypad	-		
	SMS	NAME:	20 characters	Mobeye
Alarm text power failure	Keypad	-		
	SMS	TEXT2:	20 characters	Power failure
Alarm text power restored	Keypad	-		
	SMS	TEXT3:	20 characters	Power restored
Alarm text input 1	Keypad	-		
	SMS	TEXT4:	20 characters	Alarm 1
Alarm text input 2	Keypad	-		
	SMS	TEXT5:	20 characters	Alarm 2
Text restored input 1	Keypad	-		
	SMS	TEXT6:	20 characters	Input 1 restored 2
Text restored input 2	Keypad	-		
	SMS	TEXT7:	20 characters	Input 2 restored

Program method using the keypad:

CODE (menu) menu nr. (OK) option (OK)

Program method via SMS (in program mode):

CODE COMMAND:OPTION

Or several commands at once:

CODE COMMAND:OPTION#COMMAND:OPTION#COMMAND:OPTION

Leave the menu

The menu can be left from any position, by pressing "OK" twice.

9. REPORTS AND LISTS

The programmed settings and the Mobeye MS100BK status can be requested as SMS-text message via the keypad or SMS-command (for SMS: be sure the unit is in program mode).

9.1 STATUS REQUEST

The status can be requested via 'CODE menu 501 OK' or by sending an SMS with the content:

CODE STATUS? The originator of the request receives the armed/not armed status, the status of the inputs, power and batteries as SMS text message.

9.2 LIST OF SETTINGS

The settings can be requested via 'CODE menu 10 OK' or by sending an SMS with the content:

CODE SET? The originator of the request receives the list of basic settings.

9.3 AUTHORISATION LIST

The list with authorised numbers for remote control can be requested via 'CODE menu 200 OK' or by sending an SMS with the content:

CODE ANL? The originator of the request receives the authorised numbers as list.

9.4 TEST GSM NETWORK STRENGTH

Before using the Mobeye MS100BK is it advised to test the GSM signal strength at the location.

- Enter the installation code
- Press "menu"
- Press "512"
- Press "OK"

The Mobeye MS100BK will search for all available networks. It also checks the network strength of the SIM card provider in the device. If you want to leave the function before it is ready, please press "OK" twice.

The GSM signal strength for the actual network can be read from the LED indicator:

LED	Description
Green during 30 seconds	Signal is very good
Flashing green	Signal is good
Red	Signal is weak
Flashing red	Searching, no valid SIM card or SIM card is not pin code free or no signal

The telephone number at memory position 01 will receive an SMS text message, containing all existing GSM networks, sorted by provider. It also tells the strength of each network.

Warning

In the event of a weak signal, the Mobeye MS100BK can still be used, but there is a risk that messages cannot be sent or will be received with a delay. In case of no signal, it is advised to try a different network.

10. ISSUE SOLVING AND TECHNICAL DATA

Issues

Error	Possible reason	Solution
Mobeye MS100BK cannot be switched on. You hear an error tone, the red light is turned on shortly.	No valid Telephone number was entered.	Enter a valid number.
The light is flashing red during switching on.	No valid SIM card was entered or the SIM card was not made pin code free.	Check the SIM card.
It is impossible to change the settings. After entering your personal code, followed by menu, the error tone is played and the light turns red.	Mobeye is activated.	Switch off the Mobeye MS100BK.
No GSM signal during the GSM test	No network is available, belonging to the SIM cards provider.	Choose another network provider.
The light remains red.	You entered an incorrect installation or user code three times.	Wait 10 minutes and then re-enter the correct installation or user code.
You do not receive an SMS with the settings.	Telephone number is not correct.	Re-program the telephone number at position '01'
For other questions, please refer to the site www.mobeye.eu		

Technical data

- GSM: Quad Band EGSM 850/900/1800/1900 MHz compatible to the ETSI GSM Phase 2+ standard
- Temperature range: -10°C until +55°C
- Dimensions: 161 x 90 x 35 mm (LxWxH)
- Batteries: 4 x CR123 Lithium 3.0 V
- Power, battery operated: 50 µA, short peaks of max. 2 A
- Power, ext. powered: 50 mA, short peaks of max. 2 A

For support on technical problems regarding Mobeye MS100BK please contact info@mobeye.eu.



Declaration of Conformity

Herewith we, Mobeye, declare that the product

Mobeye XM2 telemetry module

And the derived products

MS100, MS200, MS300, Call-Key

are in compliance with the essential requirements of the following European standards / EU Directives:

Directive 73/23/EEC (low voltage directive)

Directive IEC/EN 50130 Electromagnetic compatibility

Directive 2014/53/EU (RED)

The conformity with the essential requirements set out in Art.3 of the 2014/53/EU has been demonstrated against the following harmonized standards:

EN 60950-1: 2006 + A11 : 2009 + A1: 2010 + A12: 2011 + A2: 2013

EN 62311 :2008

EN 301 489-1 V2.1.1, Draft EN 301 489-52 V1.1.0

EN 301 511 V12.5.1

Mobeye B.V.
Poeldonkweg 5
5216 JX 's-Hertogenbosch
The Netherlands

Name: J.P.K. van de Vijver,

Position: General Manager

Signature:

Date: 12 July 2017

This manual is published by Mobeye.

All rights, the translation included are reserved. Any reproduction, either photocopy, microfilm or saved in an automated data dictionary, only after written approval of the Publisher. Reprinting, even in summary, is prohibited.

This user manual meets the technical requirements at the moment of printing. Changes in technology and equipment are reserved.

© Copyright 2018 by Mobeye, version MS100BKEN180401

